

QUICKIE®



S-11

User Instruction Manual & Warranty

SUPPLIER: THIS MANUAL MUST BE GIVEN TO THE RIDER OF THIS WHEELCHAIR.

RIDER: BEFORE USING THIS WHEELCHAIR READ THIS ENTIRE MANUAL AND SAVE FOR FUTURE REFERENCE.

S-11

Mode d'emploi et garantie

FOURNISSEUR: CE MANUEL DOIT ÊTRE REMIS À L'UTILISATEUR / UTILISATRICE DE CE FAUTEUIL ROULANT.

UTILISATEUR / UTILISATRICE : AVANT D'UTILISER CE FAUTEUIL ROULANT, LISEZ ENTièrement CE MANUEL ET CONSERVEZ LE POUR LE CONSULTER ULTÉRIEUREMENT.

S-11

Manual de Instrucciones y Garantía para el Usuario

DISTRIBUIDOR: ESTE MANUAL DEBE SER ENTREGADO AL PASAJERO DE ESTA SILLA DE RUEDAS.

PASAJERO: ANTES DE USAR ESTA SILLA DE RUEDAS, LEA ESTE MANUAL EN SU TOTALIDAD Y GUÁRDELO PARA FUTURA REFERENCIA.

I. INTRODUCTION

SUNRISE LISTENS

Thank you for choosing a Quickie wheelchair. We want to hear your questions or comments about this manual, the safety and reliability of your chair, and the service you receive from your Sunrise supplier. Please feel free to write or call us at the address and telephone number below:

SUNRISE MEDICAL
Customer Service Department
7477 East Dry Creek Parkway
Longmont, Colorado 80503
(800) 333-4000 or (303) 218-4500

FOR ANSWERS TO YOUR QUESTIONS

Your authorized supplier knows your wheelchair best and can answer most of your questions about chair safety, use and maintenance. For future reference, fill in the following:

Supplier: _____

Address: _____

Telephone: _____

Serial #: _____ Date/Purchased: _____

II. TABLE OF CONTENTS

I. INTRODUCTION 2

II. TABLE OF CONTENTS 3

III. YOUR CHAIR AND ITS PARTS..... 5

IV. NOTICE - READ BEFORE USE..... 6

V. EMI (ELECTROMAGNETIC INTERFERENCE) 7

 A. What is EMI 7

 B. What Effect Can EMI Have 7

 C. Sources of EMI..... 7

 D. Distance From the Source 8

 E. Immunity Level..... 8

 F. Report All Suspected EMI Incidents 8

VI. GENERAL WARNINGS 9

 A. Notice to Rider 9

 B. Notice to Attendants 9

 C. Weight Limit 9

 D. Controller Settings 9

 E. EMI..... 10

 F. Safety Check-List 10

 G. Changes & Adjustments..... 10

 H. When Seated in a Parked Wheelchair..... 10

 I. Environmental Conditions 10

 J. Terrain..... 11

 K. Street Use..... 11

 L. Motor Vehicle Safety..... 11

 M. Center of Balance..... 11

 N. Transfers 12

 O. Reaching or Leaning..... 12

 P. Dressing or Changing Clothes 13

 Q. Obstacles 13

 R. Driving in Reverse..... 13

 S. Ramps, Slopes & Sidehills..... 13

 T To Reduce the Risk of Falls, Tip-over or Loss of Control 14

 U. Ramps at Home & Work..... 14

 V. Wheelchair Lifts 14

 W. Curbs & Single Steps 15

 X. Stairs 15

 Y. Escalators 15

VII. WARNINGS: COMPONENTS & OPTIONS 16

 A. Armrests 16

 B. Batteries..... 16

 C. Cushions 16

 D. Fasteners 16

 E. Footplate & Footrests 16

 F. Motor Locks 17

 G. On/Off Switch..... 17

 H. Pneumatic Tires 17

 I. Positioning Belts..... 17

J. Seating Systems.....	17
K. Upholstery Fabric	18
L. Suspension.....	18
M. Wiring	18
VIII. SET UP, ADJUSTMENT & USE	19
Notes	19
Tools You Will Need	19
Check Out	19
A. Battery Removal	20
B. Footplate Adjustment	20
C. Hanger Adapter (Optional).....	21
D. Swing-Away Footrests	21
E. Elevating Legrest (Optional)	21
F. Integral Joystick	21
G. Armrests Adjustment	22
H. Backrest	22
I. Seat Height Adjustment	22
J. Seat Removal.....	23
K. Shroud/Fender Removal.....	23
L. Check-Out	23
IX. OPERATING GUIDE	24
A. Performance Control Settings	24
B. QTRONIX Programmer Pad (Optional).....	24
C. Thermal Roll-Back	24
D. Circuit Breakers.....	25
E. Integral Joystick Assembly	25
F. Motor Locks	26
X. BATTERIES	27
A. Introduction	27
B. Battery Charger.....	27
C. Acid Burns	28
D. Connecting Batteries in Battery Well.....	28
E. Charging Batteries.....	29
F. Disposing of Batteries.....	29
XI. MAINTENANCE	30
A. Notes	30
B. Cleaning	30
C. Storage Tips	30
D. Battery Maintenance.....	30
E. Pneumatic Tires	31
F. To Repair or Replace a Tire	31
G. Motor Brushes	31
H. Ordering Parts.....	32
I. Maintenance Chart	32
XII. WIRING DIAGRAM	33
XIII. SUNRISE LIMITED WARRANTY	34

III. YOUR CHAIR AND ITS PARTS



1. Flip-back, height-adjustable armrest
2. Integral controller joystick
3. Contour seat or Contour Flat Pan seat
4. Front caster 7"
5. Rear stabilizing caster 7"
6. Single plate foot platform
7. Semi-recline seat
8. 10" drive wheels
9. Freewheel release
10. Caster Fork (front)
11. Caster Fork (rear)
12. Shroud



S-11 with High Back Contour and Seat Pan Option

QUICKIE S-11

Weight

- 191 lbs (complete chair)
- 133 lbs (w/o batteries & footplate)
- 106 lbs (base)
- 43 lbs (seat)

Drive Wheels

- 10" Mag: Std. pneumatic,
- Option – airless insert

Joystick

- Standard – integral (right-hand or left-hand mount)

Batteries

- (2 deep cycle batteries required to operate chair)
- U1 Gel

Battery Charger

- On board 4 AMP
- Option – off board 4 AMP

Colors

- Red, Blue

Seats, Upholstery and Style

- High back chair offers semi recline
- Material: cloth or vinyl
- Color: grey
- Width: 16, 18, 20
- Depth: 16, 18, 20
- High back chair with Flat Pan Seat
- Material: vinyl
- Color: grey
- Sizes: 16"x16", 18"x18", 20"x20"

Footrest:

- Standard- Foot Platform
- Option- Swing away with composite footplates and heel loops
- Option- Elevating legrests

Casters (front)

- Standard- 7" solid

Casters (rear)

- Standard- 7" solid

Armrest

- Flip back 12" arm pad
- Option- Flip back, height adjustable 14" arm pad

Suspension

- Standard- all wheel independent

All features may not be available with some chair setups or in conjunction with another chair feature. Please consult your supplier for more information. Your authorized supplier can also provide you with more information on accessories.

IV. NOTICE– READ BEFORE USE

A. CHOOSE THE RIGHT CHAIR & SAFETY OPTIONS

Sunrise provides a choice of many power wheelchair styles, sizes and adjustments to meet the needs of the rider. However, final selection of a wheelchair rests solely with you and your health care professional. Choosing the best chair for you depends on such things as:

1. Your size, disability, strength, balance and coordination.
2. Your intended use, and your level of activity.
3. The types of hazards you must overcome in daily use (in areas where you are likely to use your chair).
4. The need for options for your safety and comfort (such as positioning belts or special seat systems).

B. ADJUST CHAIR TO YOUR ABILITY

You need to work with your doctor, nurse or therapist, and your supplier, to fit this chair and adjust the controller settings for your level of function and ability.

C. REVIEW THIS MANUAL OFTEN

Before using this chair you, and each person who may assist you, should read this entire Manual and make sure to follow all instructions. Review the warnings often, until they are second nature to you.

D. WARNINGS

The word “WARNING” refers to a hazard or unsafe practice that may cause severe injury or death to you or to other persons. The “Warnings” are in four main sections, as follows:

1. **V — EMI**
Here you will learn about electromagnetic interference and how it can affect your chair.
2. **VI — GENERAL WARNINGS**
Here you will find a safety checklist and a summary of risks you need to be aware of before you ride this chair.
3. **VII — WARNINGS — COMPONENTS & OPTIONS**
Here you will learn about your chair. Consult your supplier and your health care professional to help you choose the best set-up and options for your safety.
4. **XI — BATTERIES**
Here you will learn about battery and charger safety, and how to avoid injury.

NOTE– Where they apply, you will also find “Warnings” in other sections of this Manual.

V. EMI (ELECTROMAGNETIC INTERFERENCE)

WARNING

Heed all warnings to reduce the risk of unintended brake release or chair movement:

1. Beware of the danger from hand-held transceivers. (A “transceiver” is a device that both sends and receives radio wave signals). Never turn on or use a hand-held transceiver while power to your chair is on. Use extra care if you believe that such a device may be in use near your chair.
2. Be aware of nearby radio or TV stations, and avoid coming close to them.
3. If unintended movement occurs, turn your chair off as soon as it is safe to do so.

A. WHAT IS EMI?

WARNING

1. EMI means: electromagnetic (EM) interference (I). EMI comes from radio wave sources such as radio transmitters and transceivers.
2. There are a number of sources of intense EMI in your daily environment. Some of these are obvious and easy to avoid. Others are not, and you may not be able to avoid them.
3. Powered wheelchairs may be susceptible to electromagnetic interference (EMI) emitted from sources such as radio stations, TV stations, amateur radio (HAM) transmitters, two way radios, and cellular phones.
4. EMI can also be produced by conducted sources or electro-static discharge (ESD).

B. WHAT EFFECT CAN EMI HAVE?

WARNING

1. EMI can cause your chair, without warning, to:
 - Release its brakes
 - Move by itself
 - Move in unintended directions

If any of these occurs, it could result in severe injury to you or others.

2. EMI can damage the control system of your chair. This could create a safety hazard, and lead to costly repairs.

C. SOURCES OF EMI

WARNING

The sources of EMI fall into three broad types:

1. Hand-Held Transceivers:

The antenna is usually mounted directly on the unit. These include:

- Citizens band (CB) radios
- “Walkie-talkies”
- Security, fire and police radios
- Cellular phones
- Lap-top computers with phone or fax
- Other personal communication devices

NOTE– These devices can transmit signals while they are on, even if not in use.

2. Medium-Range Mobile Transceivers:

These include two-way radios used in police cars, fire trucks, ambulances and taxi cabs. The antenna is usually mounted on the outside of the vehicle.

3. Long-Range Transceivers:

These include commercial radio and TV broadcast antenna towers and amateur (HAM) radios.

Note: The following are not likely to cause EMI problems: Lap-top computers (without phone or fax), Cordless phones, TV sets or AM/FM radios, CD or tape players.

D. DISTANCE FROM THE SOURCE**⚠WARNING**

EM energy rapidly becomes more intense as you get closer to the source. For this reason, EMI from hand-held devices is of special concern. (See C.1 above) A person using one of these devices can bring high levels of EM energy very close to your chair without you knowing it.

E. IMMUNITY LEVEL**⚠WARNING**

1. The level of EM energy is measured in volts per meter (V/m). Every power wheelchair can resist EMI up to a certain level. This is called its "immunity level".
2. The higher the immunity level, the less the risk of EMI. It is believed that a 20 V/m immunity level will protect the power wheelchair user from the more common sources of radio waves.
3. The Quickie S-11 with the following configuration was tested and found to be immune to at least 20 V/m:
Quickie S-11 power wheelchair with a right-hand mounted Penny & Giles VSI integral controller, highback seat, flip-back armrests, solid flip-up footplate and U1 gel cell batteries.

⚠WARNING

Individuals with physical limitations requiring the use of a specialty control input device known not to be immune to 20V/m, or not known, should exercise extra care around known sources of EMI.

⚠WARNING

There is no way to know the effect on EMI if you add accessories or modify this chair. Any change to your chair may increase the risk of EMI. Parts from other suppliers have unknown EMI properties.

F. REPORT ALL SUSPECTED EMI INCIDENTS**⚠WARNING**

You should promptly report any unintended movement or brake release. Be sure to indicate whether there was a radio wave source near your chair at the time. Contact: Sunrise Medical Customer Service Department at (800) 333-4000.

VI. GENERAL WARNINGS

WARNING

Heed all warnings in this section. If you fail to do so a fall, tip-over or loss of control may occur and cause severe injury to you or others.

A. NOTICE TO RIDER

WARNING

1. Before using this chair, you should be trained in its safe use by your health care professional.
2. Every wheelchair is different. Take the time to learn the feel of this chair before you begin riding.
3. Be aware that you must develop your own methods for the safe use of this chair that are best suited to your level of function and ability.
4. Have someone help you practice bending, reaching and transferring until you learn how to do them safely.
5. Never try a new maneuver on your own unless you are sure it is safe.
6. Get to know the areas where you plan to use your chair. Look for hazards and learn how to avoid them.
7. Do not allow additional riders on the chair, armrests or chassis. Doing so may result in injury or damage.

B. NOTICE TO ATTENDANTS

WARNING

Make sure you heed all warnings and follow all instructions in each section of this manual. (Be aware that warnings that apply to the rider also apply to you).

Notes:

1. You need to work with the rider and the rider's doctor, nurse or therapist, to develop safe methods best suited to your abilities and those of the rider.
2. To manually push the chair you must release the motor locks.
Make sure you have full control over the chair when you release the motor locks.
When you do so the chair will not have brakes.
3. Propel this chair by the armrest supports only. If using a seat frame, propel the chair by the push handles on the top of the backrest. They provide secure points for you to hold the rear of the chair to prevent a fall or tip-over.

C. WEIGHT LIMIT

WARNING

1. Never exceed a total weight of 300 pounds (136.3 kilograms) for rider plus items carried.
2. Never use this chair for weight training if the total weight (rider plus additional weights) exceeds 300 pounds (136.3 kilograms).
3. Exceeding the weight limit is likely to damage the seat, frame, or fasteners and may cause severe injury to you or others from chair failure.
4. Exceeding the weight limit will void the warranty.

D. CONTROLLER SETTINGS

WARNING

Be aware that you may need to adjust the controller settings of your chair to reduce the risk of a collision, fall or tip-over.

1. Check and adjust the settings every six to twelve months (or more often, if needed).
2. Consult your supplier to adjust the control settings immediately if you notice any change in your ability to:
 - Control the joystick.
 - Hold your torso erect.
 - Avoid running into objects.

E. EMI**⚠ WARNING**

Read Section V to learn about EMI. To reduce the risk of unintended brake release or chair movement:

1. Never turn on or use a hand-held transceiver while power to your chair is on. Use extra care if you believe that such a device may be in use near your chair.
2. Be aware of nearby radio or TV stations, and avoid coming close to them.
3. If unintended movement or brake release occurs, turn your chair off as soon as it is safe.

F. SAFETY CHECK-LIST**⚠ WARNING**

Before each use of this chair:

1. Make sure the chair operates smoothly. Check for noise, vibration, or a change in ease of use. (They may indicate low tire pressure, loose fasteners, or damage to your chair). If you detect a problem, make sure to repair or adjust the chair. Deferring repair or adjustment could increase the risk for injury. Your supplier can help you find and correct the problem.
2. Make sure batteries are charged. Green lights on the controller charge indicator will light up when charge is full. Yellow lights indicate battery charge level is getting low. Red lights indicate batteries are in immediate need of charging.

G. CHANGES & ADJUSTMENTS**⚠ WARNING**

Never use non-Quickie parts or make changes to your chair unless authorized by Sunrise. (Doing so will void the Warranty and may create a safety hazard).

1. If you modify or adjust this chair it may increase the risk of a fall or tip-over.
2. Modifications unauthorized by Sunrise constitutes remanufacturing of the wheelchair. This voids the warranty. The rider then assumes all future liability for the wheelchair.

H. WHEN SEATED IN A PARKED WHEELCHAIR**⚠ WARNING**

1. Always turn off all power to your chair when you are parked, even for a moment. This will prevent:
 - Accidental movement from contact with the joystick by you or others.
 - Unintended brake release or movement from EMI sources. (See Section V)
2. Make sure that persons who help you (for example, store clerks) are aware of the joystick and do not touch it. If they do, your chair may move suddenly when you do not expect it.

I. ENVIRONMENTAL CONDITIONS**⚠ WARNING**

Your chair is not designed for use in a heavy rain storm, or in snowy or icy conditions.

1. Contact with water or excessive moisture can cause an electrical malfunction. The frame, motors and other chair parts are not watertight and may rust or corrode from the inside. To avoid a chair failure:
 - Minimize exposure of your chair to a rain storm or very wet conditions.
 - Never take your chair into a shower, tub, pool or sauna.
 - Do not use your chair in fresh or salt water (such as at the edge of a stream, lake, or ocean).
 - Make sure shroud cover and deck lid are secure.
 - Replace joystick boot if it becomes torn or cracked.
 - Make sure all electrical connections are secure.
 - Dry the chair as soon as you can if it gets wet, or if you use water to clean it.

2. Proceed slowly and use extra care if you must operate your chair on a wet or slick surface.
 - Do so only if you are sure it is safe.
 - Stop if one or both main wheels lose traction. If this occurs, you may lose control of your chair or fall.
 - Never operate your chair on a slope or ramp if there is snow, ice, water or oil film present.
 - When in doubt, have someone help you.
3. When not in use, keep your chair in a clean, dry place.

⚠ WARNING

Extra caution should be used when employing the disc switch or the proximity head array as control devices. These two devices are susceptible to malfunction when wet.

J. TERRAIN**⚠ WARNING**

1. This chair is designed for use on firm, even surfaces such as concrete, asphalt and indoor flooring.
2. Do not operate your chair in sand, loose soil or over rough terrain. Doing so may damage wheels, bearings, axles or motors, or loosen fasteners.

K. STREET USE**⚠ WARNING**

In most states, power chairs are not legal for use on public roads. Be alert to the danger of motor vehicles on roads or in parking lots.

1. At night, or when it is hard to see, use reflective tape on your chair and clothing.
2. It may be hard for drivers to see you. Make eye contact with drivers before you proceed. When in doubt, yield until you are sure it is safe.

L. MOTOR VEHICLE SAFETY**⚠ WARNING**

To date, the U.S. Department of Transportation has not approved any tie down system for transporting this wheelchair in a motor vehicle.

1. Never sit in this chair while in a moving vehicle. In an accident or sudden stop you may be thrown from the chair.
 - **Wheelchair belts are designed to position the rider only and will not protect you in an accident; further injury may result from the belts.**
2. Always move to an approved vehicle seat. You must be secured with proper motor vehicle restraints.
3. Never transport this chair in the front seat of a vehicle. It may shift and interfere with the driver.
4. Always secure this chair so that it cannot roll or shift.

M. CENTER OF BALANCE**⚠ WARNING**

The point where this chair will tip forward, back or to the side depends on its center of balance and stability.

The Center Of Balance Is Affected By:

1. The seat height and seat angle.
2. A change in your body position, posture or weight distribution.
3. Using this chair on a ramp or slope.
4. The use of a back pack or other options, and the amount of added weight.

To Reduce The Risk Of A Fall Or Tip-Over:

1. Consult your supplier for information on modifications authorized by Sunrise before you modify or adjust this chair.

NOTE– You may need to make additional changes to correct the center of balance.

2. Use extreme care until you know the balance points of this chair and how to avoid a fall or tip-over.

N. TRANSFERS**⚠ WARNING**

It is dangerous to transfer on your own. It requires good balance and agility. Be aware that there is a point during every transfer when the wheelchair seat is not below you. To avoid a fall:

1. Always turn off power before you transfer to or from your chair. If you fail to do so you may touch the joystick and cause your chair to move when you do not expect it.
2. Make sure motor locks are engaged. This keeps the chair from moving when you transfer.
3. Work with your health care professional to learn safe methods.
 - Learn how to position your body and how to support yourself during a transfer.
 - Have someone help you until you are sure you can do a safe transfer on your own.
4. Move your chair as close as you can to the seat you are transferring to. If possible, use a transfer board.
5. Rotate the front casters until they are as far forward as possible.
6. Be careful of the foot platform. If you can, remove or swing it out of the way.
 - Never stand on footrests when you transfer. Doing so may damage them or cause your chair to tip.
 - Make sure your feet do not “hang up” or get caught in the space between the footrests.
7. Make sure armrests do not interfere.
8. Transfer as far back onto the seat surface as you can. This will reduce the risk that you will miss the seat or fall.

O. REACHING OR LEANING**⚠ WARNING**

Reaching or leaning affects the center of balance of your chair. If done improperly, a fall or tip-over is likely. When in doubt, ask for help or use a device to extend your reach.

To Reduce the Risk of injury and/or Damage to the Chair:

1. Never reach or lean if you must shift your weight sideways or rise up off the seat.
2. Never reach or lean if you must move forward in your seat to do so. Always keep your buttocks in contact with the backrest.
3. Never reach with both hands (you may not be able to catch yourself to prevent a fall if you lose your balance).
4. Never try to pick up an object from the floor by reaching down between your knees.
5. Never put pressure on the foot platform while reaching. This may cause the chair to tip if you lean too far.
6. Never reach or lean over the top of the seat back. This may damage the backrest and cause you to fall.

IF YOU MUST REACH OR LEAN, DO SO AT YOUR OWN RISK.**Remember to:**

1. Move your chair as close as you can to the object you wish to reach.
2. Rotate the front casters until they are as far forward as possible. This makes the chair more stable.

NOTE– To do this: Move your chair past the object you want to reach, then back up alongside it. Backing up will rotate the casters forward.

3. Turn off all power to your chair. If you fail to do so, you may touch the joystick and cause your chair to move when you do not expect it.
4. Firmly grasp an armrest with one hand. This will help to prevent a fall if the chair tips.

P. DRESSING OR CHANGING CLOTHES

WARNING

Be aware that your weight will shift if you dress or change clothes while seated in this chair. To make the chair more stable, rotate the front casters until they are forward.

Q. OBSTACLES

WARNING

Obstacles you may have to overcome in daily use include door thresholds, lifts, ramps and hazards such as potholes and broken pavement. These can damage your chair and may cause a fall, tip-over or loss of control.

1. Be aware that thresholds are very dangerous. (Even a small change in height may stop a caster wheel and cause your chair to tip). You may need to:
 - Remove or cover threshold strips between rooms.
 - Install a ramp at entry or exit doors.
2. Keep your eyes moving when you ride; scan the area well ahead of your chair.
3. Make sure the floor areas where you use this chair are level and free of obstacles.
4. To help correct your center of balance:
 - Lean your upper body forward slightly as you go up over an obstacle.
 - Press your upper body backward as you go down from a higher to a lower level.

R. DRIVING IN REVERSE

WARNING

Use extra care when you drive your chair in reverse. You may lose control or fall if one of the rear wheels hits an object.

1. Operate your chair slowly and at an even speed.
2. Stop often and check to make sure your path is clear of obstacles.

S. RAMPS, SLOPES & SIDEHILLS

WARNING

The center of balance of your chair changes when you are on a slope.

NOTE- "Slope" includes a ramp or sidehill. Your chair is less stable when it is at an angle. Never use this chair on a slope unless you are sure it is safe.
When in doubt, have someone help you.

Beware Of:

1. Steep slopes. Do Not use this chair on a slope steeper than 10%. (A 10% slope means: One foot in elevation for every ten feet of slope length).
2. Wet or slippery surfaces (such as when ice, snow, water or oil film is present). A loss of traction may cause a fall or tip-over.
3. A change in grade on a slope (or a lip, bump or depression). These may cause a fall or tip-over.
4. A drop-off at the bottom of a slope. (A drop-off of as small as 3/4 inch can stop a front caster and cause the chair to tip forward).

T. TO REDUCE THE RISK OF A FALL, TIP-OVER OR LOSS OF CONTROL**⚠ WARNING**

1. Never use your chair on a slope unless you are sure you can do so without losing traction.
2. Always go as straight up and as straight down as you can.
 - Do not “cut the corner” on a slope or ramp.
 - Do not turn or change direction on a slope.
3. Always stay in the center of the ramp. Make sure ramp is wide enough that you are not at risk that a wheel may roll off the side.
4. Lean or press your body uphill. This will help adjust for a change in the center of balance caused by the slope. (Figure 1)
5. Keep your chair moving at a slow, steady speed. Keep control over the chair at all times.
 - On a descent, do not let your chair accelerate beyond its normal speed.
 - If the chair picks up speed, center the joystick to slow down or stop.

NOTE– The solid state controller of your chair has a logic system that will help control your speed when driving on a slope or uphill.

- If you stop, re-start slowly.

U. RAMPS AT HOME & WORK**⚠ WARNING**

Make sure ramps meet all Building Codes for your area.

1. For your safety, have a licensed contractor build or remodel ramp to meet all standards.
2. **NOTE**– The proper design will vary, depending on such things as: the length and height of the ramp; the need for an intermediate platform; landing size; doors and the direction of swing; and whether the ramp includes a turn or angle.

At A Minimum:

1. Open sides of ramp must have side rails to prevent your chair from going over the edge.
2. Slope must not be steeper than one inch in height for every one foot of slope length.
3. Ramp surface must be even, and have a non-skid surface.
4. You may need to add a section at the top or bottom to avoid a lip or drop-off.
5. Ramp must be sturdy. Add bracing if needed, so ramp does not “bow” when you ride on it.

V. WHEELCHAIR LIFTS**⚠ WARNING**

Wheelchair lifts are used in vans, buses, and buildings to help you move from one level to another.

1. Always turn off all power to your chair when you are on a lift. If you fail to do so, you may touch the joystick by accident and cause your chair to drive off the platform. (Be aware that a “roll-stop” at the end of the platform may not prevent this).
2. Make sure there is not a lip or drop-off at the top or bottom of the platform. These may cause a fall or tip-over. When in doubt, have someone help you.
3. Always secure the rider with a positioning belt to help prevent falls during transfers.
4. Avoid moving forward if a wheel is “hung up” on the lip of the ramp. Backup, reposition the caster for a more direct approach and slowly try again.



Figure 1

W. CURBS & SINGLE STEPS** WARNING**

1. Your chair is not designed to drive up or down a curb or step more than two (2.0) inches high. Doing so may:
 - Result in a fall or tip-over.
 - Damage the frame, wheels, axles or other chair parts, or loosen fasteners.
2. To prevent a fall or tip-over, use wheelchair access ramps or have someone help you.
3. If you must climb or descend a curb or step alone do so at your own risk and use extreme care.
 - Go as straight up or straight down as you can. Never turn or climb or descend at an angle as a fall or tip-over is likely.
 - Proceed slowly, at a steady speed.
4. Avoid driving along curb edges and drop-offs. A minimum distance from the edge of 18" is recommended.

X. STAIRS** WARNING**

Never use this chair to go up or down stairs, even with an attendant. Doing so is likely to cause a fall or tip-over.

Y. ESCALATORS** WARNING**

Never take this chair on an escalator, even with an attendant. Doing so is likely to cause a fall or tip-over.

VII. WARNINGS: COMPONENTS & OPTIONS

⚠ WARNING

Note: If you use parts or make changes not authorized by Sunrise it may create a safety hazard and will void the Warranty.

A. ARMRESTS

⚠ WARNING

Armrests flip back and cannot be used to lift chair or the seat.

1. Never lift this chair by its armrests.
2. Lift this chair only by non-detachable parts of the main frame.

B. BATTERIES

⚠ WARNING

1. Only deep cycle sealed case construction batteries should be used in this device.
2. To prevent an acid spill, always keep batteries upright. (wet cell batteries only)
3. Never smoke or hold an open flame near batteries. They are a known explosion hazard.
4. Always wear rubber gloves and safety glasses when you handle batteries.
5. Read all of section XI Batteries before attempting to change or charge batteries.
6. Always remove batteries using straps or handle provided. Pinched fingers may occur if the batteries are removed by grasping the battery casings.

C. CUSHIONS

⚠ WARNING

1. Quickie Highback seats are designed for comfort, not specifically for the relief of pressure.
2. If you suffer from pressure sores, or if you are at risk that they will occur, you may need a special seat system such as can be provided by the Seat Frame, or a device to control your posture.
 - Consult your doctor, nurse or therapist to find out if you need such a device for your well-being.

D. FASTENERS

⚠ WARNING

Many of the screws, bolts and nuts on this chair are special high-strength fasteners. Use of improper fasteners may cause your chair to fail.

1. Only use fasteners provided by Sunrise.
2. If fasteners become loose, tighten them as soon as you can.
3. Over- or under-tightened fasteners may fail or cause damage to chair parts.
 - See Section IX, "Set-Up, Adjustment & Use", for proper torque settings.

E. FOOTPLATE & FOOTRESTS

⚠ WARNING

1. At the lowest point, the foot platform and footrests should be at least 2 1/2" off the ground. If set too LOW, it may "hang up" on obstacles you can expect to find in normal use. This may cause the chair to stop suddenly and tip forward.
2. To avoid a trip or fall when you transfer:
 - Make sure your feet do not "hang up" or get caught in the space surrounding or in between the footrests.
 - Avoid putting weight on the footplate or footrests, as the chair may tip forward.
 - Flip the footplate back or swing the footrests out of the way, if possible.
3. Never lift this chair by the footplate or footrests. Footrests fold or detach and will not bear the weight of this chair. Lift this chair only by non-detachable parts of the main frame.

F. MOTOR LOCKS**⚠ WARNING**

1. Do not engage or disengage motor locks unless power to the chair is off.
2. Be aware that the chair will not have brakes when motor locks are in the free-wheel position. (See Section F of Operating Guide.)
3. Make sure that the person pushing the chair has full control when motor locks are disengaged.

G. ON/OFF SWITCH**⚠ WARNING**

1. Never use the ON/OFF switch to stop the chair except in an emergency. This will result in an abrupt stop and may cause you to fall.
2. To slow your chair to a stop, return the joystick to neutral, before turning off the chair.

H. PNEUMATIC TIRES**⚠ WARNING**

Proper inflation extends the life of your tires and makes your chair easier to use.

1. Do not use this chair if any of the tires are under- or over-inflated. Check weekly for proper inflation level, as listed on the tire sidewall.
2. Low pressure in a tire may cause the chair to veer to one side and result in a loss of control.
3. An over-inflated tire may burst.
4. Never use a gas station air pump to inflate a tire. Such pumps provide air at high volume, and could cause the tire to burst. To prevent tire damage:
 - Use a hand pump (or a low volume air pump) to inflate tires.
 - Use a tire gauge to check pressure.
5. Driving over sharp objects may cause damage to pneumatic tires and tubes.

I. POSITIONING BELTS**⚠ WARNING**

Use a positioning belt only to help support your posture. Improper use of such belts may cause severe injury or death.

1. Make sure you are not at risk to slide down in the wheelchair seat. If this occurs, you may suffer chest compression or suffocate due to pressure from the belt.
2. A pelvic wedge or a similar device can help you from sliding down in the seat. Consult your health care professional to find out if you need such a device.
3. The belt must be snug, but must not be so tight that it interferes with breathing. You should be able to slide your open hand, flat, between the belt and your stomach.
4. Make sure you can easily remove the belt in an emergency.
5. Never use a positioning belt:
 - In place of a motor vehicle seat belt. In an accident or sudden stop you may be thrown from the chair. A positioning belt will not prevent this, and further injury may result from the belt.
 - As a restraint. A restraint requires a doctor's order.
 - On a rider who is comatose or agitated.

J. SEATING SYSTEMS**⚠ WARNING**

1. Use of a seating system not approved by Sunrise may alter the center of balance of this chair. This may cause a fall or tip-over.
2. Never change the seating system of your chair unless you consult your supplier first.

K. UPHOLSTERY FABRIC**⚠ WARNING**

1. Replace worn or torn fabric of the seat as soon as you can. If you fail to do so, the seat may fail and cause you to fall. Worn fabrics may increase the potential for a fire hazard.
2. Fabric will deteriorate with age and use. Look for fraying, thin spots, or stretching of fabric at rivet holes. Replace fabric as required.
3. Be aware that washing may reduce flame retardation of the fabric.

L. SUSPENSION**⚠ WARNING**

The suspension system does contain Dry Natural Rubber. The suspension, or any other component on the chair, does not contain any latex based product. The suspension components are enclosed and inaccessible to the user.

M. WIRING**⚠ WARNING**

Never pull on cables directly. This can result in wires breaking inside the connector or harness. To remove a plug or connector, always grasp the plug or connector itself.

VIII. SET-UP, ADJUSTMENT & USE**NOTES:****1. Work Surface For Set-Up:**

Use a flat surface, such as a table, to assemble, adjust and check your chair. This makes the steps easier and helps ensure a correct set-up.

2. Fasteners:

- Many of the screws and bolts on this chair are special high-strength fasteners and may have special coatings.
- Many nuts are of the Nylock type. They have a plastic insert to help prevent loosening.

⚠WARNING

1. **Use of improper fasteners may cause the chair to fail.**
2. **Over- or under-tightened fasteners may fail or cause damage to chair parts.**
3. **If bolts or screws become loose, tighten them as soon as you can. Loose bolts or screws can cause damage to other chair parts causing them to fail.**

3. Washers & Spacers:

- Note the position of washers and spacers before disassembly.
- To avoid damage to the frame, replace all washers and spacers when you reassemble parts.

4. Torque Settings:

- A torque setting is the optimal tightening for a particular fastener. Use a torque wrench that measures 120 inch-pounds to secure screws, nuts and bolts on this chair.

NOTE– Unless otherwise noted, use a torque setting of 120 inch-pounds for all fasteners.

TOOLS YOU WILL NEED**1. Basic Tool Kit:**

To set-up, adjust and maintain your chair you will need the following tools:

- 3mm Allen Wrench
- 5mm Allen Wrench
- 6mm Allen Wrench
- 13mm Open-end Wrench
- 18mm Open-end Wrench
- Phillips screwdriver #2
- Flat-head screwdriver
- 13mm Socket Wrench

You can obtain a multi-purpose tool kit from Sunrise, or buy the tools you need from a hardware store.

2. Torque Wrench:

If you plan to adjust and maintain this chair yourself, Sunrise recommends that you use a torque wrench.

NOTE– The wrench must measure inch-pounds. You can buy a torque wrench and proper sockets from a hardware store.

CHECK-OUT

Be sure this chair performs to your chosen operational settings. If it does not, turn the chair off immediately and reprogram with the Quickie QTRONIX Programmer. If you do not own a Quickie QTRONIX Programmer have your supplier reprogram your wheelchair as needed. Or, you can order a Quickie QTRONIX Pad for your own use, from your supplier.

NOTE– Repeat this procedure until the chair performs to your specifications.

⚠WARNING

When properly set up, this chair will operate smoothly. Check to see that all components work properly. If you detect a problem, be sure to correct it before use.

A. BATTERY REMOVAL (Figures 1 & 2)

To remove the batteries for transporting or servicing:

1. Remove Batteries

- a. Disconnect the joystick power cable in the rear of the chair.
- b. Pull up on both release levers, and tilt the seat forward slowly.
- c. Remove the Velcro-attached shroud by lifting up.
- d. Unwrap the battery strap; unplug and remove batteries from the chair.
- e. Lift batteries using battery handles.

2. Battery Installation

See Section X. Batteries, D for installation and wiring diagram.

⚠ WARNING

Batteries may weigh up to 45 lbs. Care must be taken to avoid injury when lifting up on battery straps.

B. FOOTPLATE ADJUSTMENT

The single footplate can be adjusted in three different ways: height, length, and angle.

1. Height Adjustment (Figure 3)

(3 possible adjustments):

- a. Remove pin (A).
- b. Move footplate to desired height and slide it into slot.
- c. Re-install pin (A) through desired hole.

2. Length Adjustment (Figure 4)

(4 possible adjustments):

- a. Remove pin (B).
- b. Move footplate to desired length.
- c. Re-install pin (B) through desired hole.

3. Angle Adjustment (Figure 5)

Adjust bolt (C) until desired angle is reached.

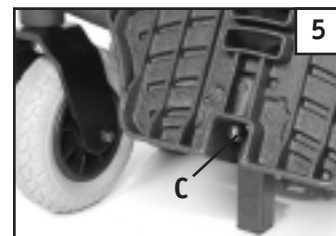
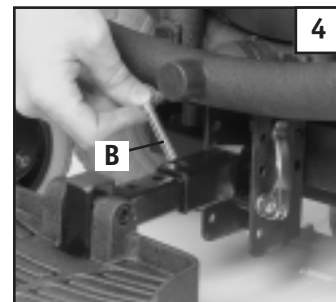
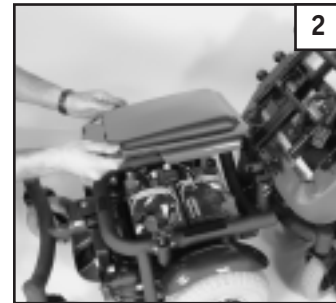

C. HANGER ADAPTER (OPTIONAL)

(Figure 6)

1. Insert hanger adapter into seat frame interface.
2. Tighten thumb screws.

D. SWING-AWAY FOOTRESTS**1. Installation**

(Figure 7)

- a. Place swing-away on hanger adapter pins.
- b. Rotate the footrest inward until latch plate locks into place on locking bolt.

2. Removal

(Figure 8)

- a. To remove footrest, press quick-release lever.
- b. Rotate footrest outward and lift.

3. Height Adjustment

(Figure 9)

- a. Loosen the bolts in the hanger frame tube and the clamp.
- b. Reposition footrest height.
- c. Re-tighten bolts.

⚠ WARNING

Avoid opening doors with footplate or legrests. Damage or injury may result.

E. ELEVATING LEGREST (OPTIONAL)

(Figure 10)

1. Installation

To install or remove Elevating Legrest (ELR) see instructions for Swing-away Footrest installation above.

2. Adjustment

- a. To raise legrest, lift to desired position. Legrest will automatically lock in place.
- b. To lower legrest, while seated in chair, first lift slightly, then press release lever up and lower legrest to desired position.
- c. To adjust the footplate height, see instructions for the swing-away footrests above.

F. INTEGRAL JOYSTICK

(Figure 11)

1. To Connect

- a. Line up receptacle on large rectangular connector (Beau Connector) and AMP connector located behind the seat with the pins on the connector located on the joystick harness.
- b. Push in firmly.

2. To Disconnect

Pull up on beau connector until it disconnects from the frame mounted receptacle, located behind the seat. **Pinch the sides** of the AMP connector and then pull.

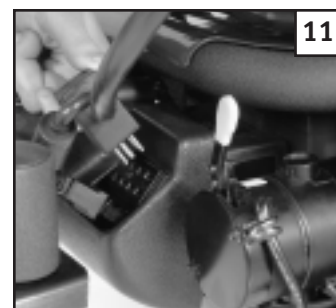
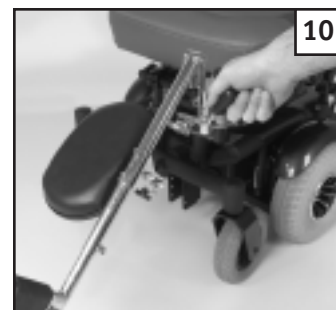

G. ARMRESTS ADJUSTMENT

1. Width Adjustment (Figure 12)

- Insert armrest support inside of 1" square tube (B) located on back of the seat.
- Repeat for other side of seat.
- Position armrest at appropriate width.
- Tighten knob screws (C) on square tube.

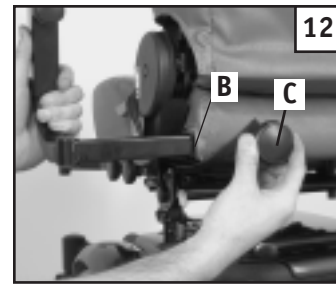

2. Angle Adjustment (Figure 13)

- Flip back armrest.
- Adjust the angle of the armrest by turning the bolt (D) clockwise to reduce the angle and counter clockwise to increase the angle.
- Fully tighten the jam nut.

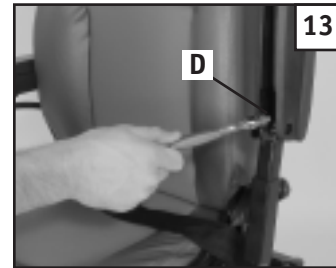

3. Height Adjustment (Figure 14)

- Remove the knob screw (E).
- Select the desired armrest height.
- Reinsert the knob screw and tighten.

⚠ WARNING

Avoid pinching fingers in the flip-back armrest.

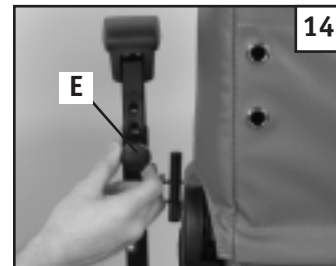

H. BACKREST

Adjustment for the High Back Contour Seat

(Figure 15)

- Pull lever (H) upwards.
- Lean back to desired position.
- Release lever (H).

CAUTION– Backrest latches must be locked into place before operating wheelchair.

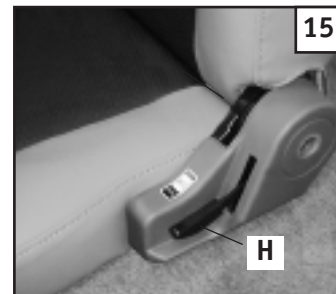

I. SEAT HEIGHT ADJUSTMENT

(Figure 16)

- Remove seat (See Section J).
- Remove pins from all four seat mount posts.
- Select the desired seat height (rear seat mount should never be more than one position lower than the front).
- Reinsert the pins.

⚠ WARNING

Ensure both front seat posts are positioned to the same height. Rear seat posts should also be set to the same height.



J. SEAT REMOVAL

1. Remove Seat (Figures 17, 18 & 19)

- Disconnect the joystick power cable in the rear of the chair.
- To remove the seat: release the safety lock-out pin (Fig. 17), pull up on both release mechanisms (Fig. 18), and tilt the seat forward.
- Loosen the screws on each side of the front seat mount.
- Slide the seat backwards and lift off.
- When replacing the seat into the mounts, ensure you do not pinch your fingers.

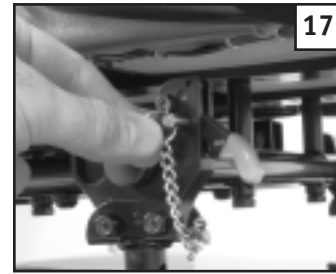

2. Seat Fore/Aft Adjustability (Figure 20)

- Unscrew four bolts underneath the seat that attach the seat to the seat frame.
- Adjust forward or backward to desired position.
- Tighten all four bolts.

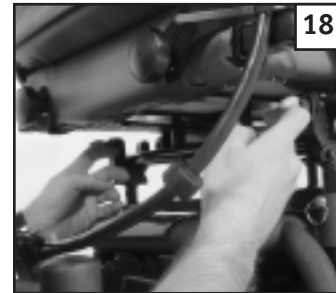

⚠ WARNING

Always replace the safety lock-out pin to prevent inadvertent release of the seat.

K. SHROUD/FENDER REMOVAL (Figure 21)

The plastic protective shroud can be removed for adjustment or servicing.

1. Remove Shroud

- Remove the seat (see Section J).
- Remove the Velcro attached shroud by lifting up.

2. Replace Shroud

Replace shroud by reversing above instructions.

3. Remove Fenders

After removing the shroud, unscrew the two screws holding the fenders in place (Fig. 21).



L. CHECK-OUT

Once the wheelchair is assembled and adjusted, it should roll smoothly and easily. All accessories should also perform smoothly.

After the wheelchair has been set up be sure the chair performs to your specified operational settings (see Operating Guide). If the chair does not perform to specifications, turn the wheelchair OFF immediately and reprogram operational specifications using the QTRON-IX Programming Pad (see section B of Operating Guide).

Repeat this procedure until the wheelchair performs to specifications before attempting active use of the wheelchair.

If you have any problems, follow these procedures:

- Review the Set-up, Adjustment & Use section and Operating Guide to make sure chair was properly prepared.
- If your problem persists, contact your authorized supplier. If you still have a problem after contacting your authorized supplier, contact Sunrise customer service. See the introduction page for details on how to contact your authorized supplier or Sunrise customer service.

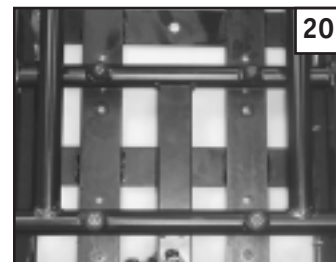

IX. OPERATING GUIDE

A. PERFORMANCE CONTROL SETTINGS

1. It is vital to match control settings to your level of function and ability.
2. Consult your health care professional and your supplier to select the best control settings for you.
3. Check and adjust the settings every six to twelve months (or more often, if needed).
4. Adjust the control settings immediately if you notice any change in your ability to:
 - Control the joystick.
 - Hold your torso erect.
 - Avoid running into objects.
5. Control Settings are adjusted through the use of the Quickie QTRONIX Programming Pad. See your supplier if you do not own a Quickie QTRONIX Programming Pad.

B. QUICKIE QTRONIX PROGRAMMER PAD (OPTIONAL)

⚠ WARNING

Program settings beyond the ability of the rider can result in serious injury. Consult your health care advisor before you alter settings.

1. Notes:

The Quickie QTRONIX Programmer lets you adjust the performance control settings of the P-

11. You can customize a program for yourself or select the standard program.

- acceleration rate
- deceleration rate
- turn acceleration
- turn deceleration
- forward speed (max & min)
- reverse speed (max & min)
- turn speed (max & min)
- steer correct

Remote systems

- 4-axis joystick throw
- sleep timer
- profile number
- read timer

2. To Program Your Chair:

- a. Turn off power to the chair.
- b. Insert Quickie QTRONIX Programmer plug (A) into the programmer/charger socket on the front of the joystick.
- c. Turn on power to the chair; program as needed.
- d. Remove plug and cycle ON/OFF switch to drive chair.

NOTE– Review the Quickie QTRONIX Programmer Owner's Manual for more details on how to program your chair.

NOTE– Program settings that are not matched for the capabilities of the rider can result in serious injury. Do not alter settings without the advice of your health care professional.

C. THERMAL ROLL-BACK

Your chair has a thermal roll back circuit. This protects the controller from damage due to overheating. In extreme conditions (such as repetitive hill climbing) the circuit will decrease the power to your motors. This allows the chair to operate at a reduced speed. When the controller cools, the chair will return to normal speed.

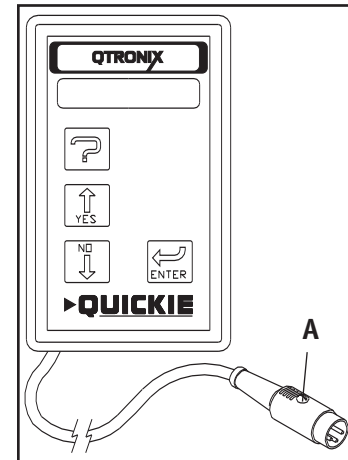

D. CIRCUIT BREAKERS

1. Notes:

Your Quickie S-11 has a circuit breaker at the left rear of the chair.

- In the unlikely event of a short circuit or heavy overload, all power to your chair will be shut off.
- To reset your chair, depress the circuit breaker button located at the rear corner of the chair. A few minutes wait is required before the circuit breaker will reset.

2. Repeated Shutdown:

If the chair continues to shut down after resetting, have it serviced by a supplier.

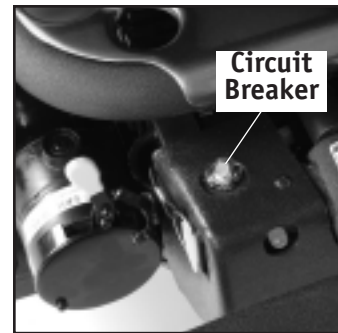

E. JOYSTICK ASSEMBLY

The standard integral joystick controls the chair's performance. It consists of the following parts:

1. Speed Control or Drive Mode Selection Buttons (A and B)

To decrease the speed level depress button A. Or, when 1- 5 Drive modes are programmed, depress button A to activate lower drive mode(s).

To increase speed level, depress button B. Or, when 1- 5 Drive modes are programmed, depress button B to activate higher drive mode(s).

Speed level active, or Drive Mode selected, is indicated on display (C) by a series of five lights. One light indicates slowest level/mode currently active, while five lights indicates highest level/mode currently active.

2. Battery Charge Indicator (D)

- Green lights indicate that batteries are fully charged.
- Yellow lights indicate that batteries need recharging.
- When the lights stay in the red band, the batteries must be recharged.

3. On/Off Button (E)

Turning the chair on or off is accomplished by depressing button E.

4. Horn (F)

5. Joystick (G)

The joystick controls the direction and speed of your chair. Turn the chair on and move the joystick in the direction you want to go.

- Moving the joystick from the neutral (center) position disengages the motor locks, allowing the chair to move.
- The chair will move faster the more you move the joystick away from neutral.

NOTE- If your speed becomes hard to manage, release the Joystick and the chair will come to a complete stop.

- When you release the joystick it will return to neutral; the chair will slow to a stop and the motor locks will reengage.
- We recommend that you switch the chair off if you stop for any length of time. This will conserve battery power.

NOTE- Once the chair stops, switching the chair off will not affect the motor locks.

6. Joystick Boot (H)

Make sure the boot is not torn or cracked (this could allow debris, water or moisture to enter). If the boot is torn or cracked, replace it as soon as you can.

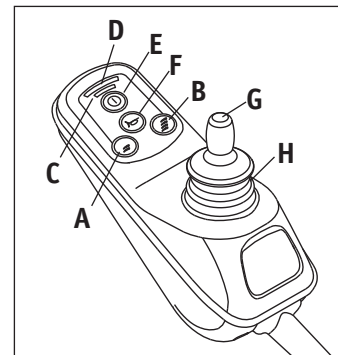

Integral Joystick

F. MOTOR LOCKS

Disconnect the motor locks when you need to manually push the chair.
(For example, in an emergency, or if batteries fail).

⚠ WARNING

1. Do not disengage motor locks unless power to the chair is off.
2. With either one or both brakes released, the chair will not operate and the battery charge indicator will flash 9 bars rapidly (if power to the chair is on.)
3. Be aware that the chair will not have brakes in the free-wheel position.
4. Make sure that the person pushing the chair has full control when motor locks are disengaged.

1. Release Motor Locks

- a. The motor release levers (A) are attached to the rear section of the motors located at the back of the chair.
- b. Push the release levers inward toward the center of the chair.

2. Engage Motor Locks

- a. The motor release levers (A) are attached to the rear section of the motors located at the back of the chair.
- b. Push the motor release levers out, away from the center of the chair.

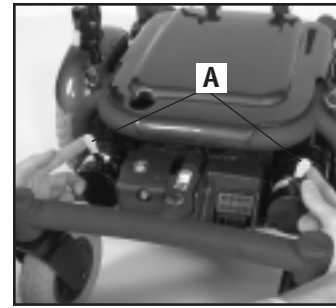

X. BATTERIES

A. INTRODUCTION

1. Notes:

- Batteries supply the power for your chair. They contain a finite amount of energy and have limits on how long they can store and supply energy.
- You can charge batteries only a certain number of times before they will fail and no longer hold a charge.
- For answers to questions about batteries, consult your supplier.

2. Use Proper Batteries:

Your chair operates on two 12 volt batteries.

- They should be U1 batteries.
- When you buy a replacement, insist on a deep cycle sealed case. Do not use a car starter battery.

3. Breaking In:

- A battery requires “breaking-in” for the first 6 to 12 charges. It will not accept a full charge for this period.
- It is best to limit the length of your trips until you break the batteries in and you know the range of your chair.

4. Discharged Batteries:

- **Never** allow a battery to completely discharge. If you operate your wheelchair until it has almost stopped, you will greatly reduce the life of your batteries.
- **Never** let a battery sit in a discharged condition. Give unused or stored batteries a full charge once per month.
- **Always** fully charge the batteries. Avoid “topping off” with frequent charges.

⚠ WARNING

Never connect a life support or auxiliary device to a wheelchair battery. The electrical system may fail and result in severe injury to or death of rider.

B. BATTERY CHARGER

A battery charger produces a direct current (DC). When applied to a discharged battery, this reverses the chemical reaction that led to its discharge.

1. Charge Rate. How fast a battery will charge depends on:

- Its electrical capacity, state of charge, electrolyte temperature, and internal condition.
- The DC output of the charger. (The charge rate will vary if the alternating current (AC) supply is higher or lower than 110 volts).

2. CAUTION– To Avoid Damage to the Charger

- **Never** expose charger to rain or snow.
- **Never** unplug charger by pulling on the electrical cord. This will damage the cord.
- **Never** open a charger or attempt to repair it yourself. Return charger to Sunrise or have repairs made only by a qualified person.
- Keep cord out of the way, where it will not be stepped on, tripped over, or damaged.

3. CAUTION– To Avoid Damage to the Battery

- Make sure you use the correct setting for sealed (gel) batteries (located on the off-board charger).
- **Never** charge a frozen battery. A fully charged battery will rarely freeze, but the fluid in a discharged battery can freeze at 16 degrees Fahrenheit (minus 9 degrees Centigrade). If you suspect a battery is frozen, thaw it before charging.

⚠ WARNING

Lead acid batteries generate explosive gas while charging. Completely read and follow all warnings about the batteries in this user instruction manual and any labels applied to the product. Failure to do so could result in fire, explosion, injury and/or death.

C. ACID BURNS (UNSEALED WET CELL BATTERIES)

Acid in batteries is corrosive. If you choose to use wet cell batteries, they can cause serious burns to the eyes and skin and can damage floors, furniture, clothing and your wheelchair.

⚠ WARNING

1. Use extreme care not to spill acid when you handle wet cell batteries. Keep batteries upright.
2. Avoid contact of acid with bare skin or clothing.
3. Always wear rubber gloves and safety glasses when you handle batteries.
4. If acid contacts your skin or clothing, wash immediately with soap and water.
5. If acid contacts your eyes, immediately flood eyes with cold running water for at least 15 minutes. Seek medical attention immediately.

Sunrise Medical does not recommend the use of wet cell batteries on this chair.

D. CONNECTING BATTERIES IN BATTERY WELL

⚠ WARNING

1. Each battery weighs up to 45 lbs. Take care to avoid injury when lifting.
 2. Keep batteries upright. Take care not to spill acid (wet cell batteries).
 3. Always wear rubber gloves and safety glasses when you handle batteries.
 4. Before working around batteries, remove all metal personal effects, such as necklaces, rings, watches, pins, and other metal jewelry that might contact battery terminal and cause a short.
1. Attach battery harness to battery post. Connect red to positive terminal and black to negative terminal.
 2. Tighten all terminal fasteners using two wrenches.
 3. Cover battery posts with insulating caps on harness.
 4. Lift batteries into battery well.

⚠ WARNING

Batteries weigh up to 45 pounds. Lifting batteries may cause back strain. If you fail to heed these warnings severe injury may occur to you.

5. Plug battery harness into chair harness.
6. Place shroud into position.

⚠ WARNING

Never make direct contact across both battery terminals, as an explosion may occur. A spark may result in an explosion and/or fire resulting in severe injury or death.

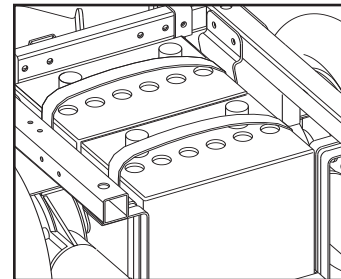

Refer to wiring diagram for battery connections

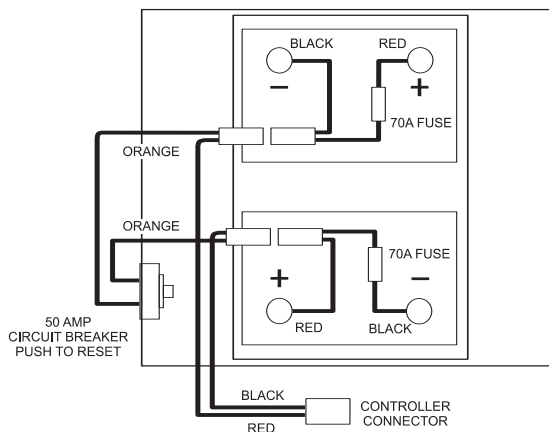

E. CHARGING BATTERIES

⚠ WARNING

To avoid the risk of severe injury or death from electrical shock, fire or explosion while charging:

1. **Never** connect charger to a 240 volt source. The main input voltage is 110 volts.
2. **Never** touch the charger after it is connected to an electrical outlet. This may cause electrical shock.
 - **Never** connect or disconnect charger from battery while there is power to the charger.
3. **Never** use an extension cord. Use of an improper cord could damage the charger or cause a fire or electrical shock.
4. A battery emits explosive hydrogen gas during charging. To reduce the risk of fire or explosion:
 - Make sure area is well vented. Never charge battery in a closed-in area.
 - Never smoke or allow a spark, flame or high heat near battery during charging.
 - Never allow metal tools or chair parts to make direct contact across both battery terminals.
5. Never look directly into cells when charging battery (wet cell batteries).

ALWAYS:

1. Use the charger that comes with your wheelchair. Read and follow all instructions and warnings.
2. Make sure room is well ventilated.
3. Turn off all power to your chair.
4. Connect and disconnect battery cables with caution.
5. Make sure to allow enough time to fully charge batteries.

NOTE- Batteries should never be left for long periods in the discharged state. Unused or stored batteries should be given a charge once per month.

6. Charge batteries by plugging in the battery charger cord into the chair and an outlet.
7. Or, use the off-board charger by plugging it into the integral controller.

F. DISPOSING OF BATTERIES

⚠ WARNING

1. All batteries once they have reached the end of their useful life are deemed to be hazardous waste.
2. For further information on handling and recycling contact your local recycling authority.
3. Always dispose of product through a recognized agent.



On-board charger port

On-board charging LED:
yellow- charging
green- fully charged



Off-board charger port

(located under controller)

XI. MAINTENANCE

A. NOTES

1. Proper maintenance will improve performance and extend the useful life of your chair.
2. Clean your chair regularly. This will help you find loose or worn parts and will make your chair easier to use.
3. To protect your investment, have all major service and repair work done by your supplier.

⚠ WARNING

1. **Your chair needs regular maintenance for peak performance and to avoid injury from chair failure, damage or premature wear.**
2. **Inspect and maintain this chair strictly per the "Maintenance Chart".**
3. **If you detect a problem, make sure to service or repair the chair before use.**
4. **At least once a year, have a complete safety check and service of your chair performed by a supplier.**

B. CLEANING

1. Plastic Shroud Cover and Fenders:

- Clean the plastic finish with mild soapy water monthly.

2. Motors:

- Clean around motor area weekly with a slightly damp (not wet) cloth.
- Wipe off or blow away any fluff, dust, or dirt on or around the motors.
- Note: You do not need to grease or oil the chair.

3. Upholstery:

- Hand-wash only as needed. Machine washing may damage fabric (rehab seat only).
- Drip-dry only. Heat from a dryer may damage fabric.

NOTE– Washing the fabric may decrease fire retardant properties.

C. STORAGE TIPS

1. Store your chair in a clean, dry area. If you fail to do so, parts may rust or corrode.
2. Before using your chair, make sure it is in proper working order. Inspect and service all items on the "Maintenance Chart".
3. If you store this chair for more than three months, have it inspected by a supplier before use.

D. BATTERY MAINTENANCE

⚠ WARNING

1. **To prevent an acid spill, always keep batteries upright. (wet cell batteries)**
2. **Never smoke or hold an open flame near batteries.**
3. **Always wear rubber gloves and safety glasses when you handle batteries.**

1. Maintenance Schedule:

This varies for different types of batteries. Always follow the instructions supplied with your batteries.

NOTE– Always wear rubber gloves and safety glasses when you handle or service batteries.

2. Adding Water: (Wet Cells Only)

- Wet-type lead acid batteries need periodic replacement of water lost.

NOTE– Use distilled water only.

- Check the battery fluid level about once a week. When you remove the stoppers (on top of the battery) there should be one-eighth to one-quarter of an inch of fluid above the internal plates. Do not overfill.

3. Corrosion:

Check battery terminals often for corrosion.

- a. If corrosion is present, use a wire brush to clean the terminals.

NOTE– Always wear safety glasses and rubber gloves.

- b. Use baking soda to neutralize acid.
- c. Use petroleum jelly to re-grease the terminals after connecting cables to battery.
(Completely cover the terminal nut and bolt, cable clip and any exposed cable with jelly).

4. For Answers To Questions: Contact your supplier.**E. PNEUMATIC TIRES****⚠ WARNING**

1. Do not use this chair if any of the tires are under-inflated or over-inflated.
2. Low pressure in a tire may cause the chair to veer to one side and result in loss of control.
3. An over-inflated tire may burst.
4. Never use a gas station pump to inflate a tire. Such pumps provide air at high volume, and may cause tire to burst.

1. Check for signs of wear and correct air pressure in pneumatic tires weekly.
2. For best performance, inflate tires to the same pressure level, as shown on the tire sidewall:
 - 10" pneumatic drive wheels - 30 to 40 psi

3. Caution:

To prevent tire damage:

- Use a hand pump (or a low volume air pump) to inflate tires.
- Use a tire gauge to check pressure.

F. TO REPAIR OR REPLACE A TIRE**⚠ WARNING**

Residual air pressure in tires can cause severe injury. Make sure you release all air in tire before attempting to service or repair tires.

Drive Wheels:

- a. Elevate and securely support chair so that wheel is off the ground. Release all air from tire (solid aluminum rim only).
- b. Bend locking tab away from bolt.
- c. Remove lock bolt.
- d. Remove wheel from chair.
- e. Make sure all air has been removed from tube.
- f. Remove all bolts holding two halves of rim together (not applicable on solid aluminum rim), and remove tire and solid insert.
- g. Repair or replace inner tube (replace rim strip if necessary).

NOTE– Do not use pneumatic inner tube in tires with two-piece rims.

- h. Reassemble the wheel.
Use a torque setting of 420 in.-lbs. to re-tighten bolts.
- i. Install wheel on chair by replacing center lock bolt. Use a torque setting of 180 in.-lbs. to retighten bolts.
- j. Inflate tire to proper pressure level (listed on tire sidewall).

G. MOTOR BRUSHES

Check the motor brushes every four (4) months for wear. The brushes should be clean and shiny. Replace worn or blackened brushes.



H. ORDERING PARTS

When you order parts, provide the following:

1. Model of chair
2. Serial number of chair
3. Left hand or right hand control
4. Part number, description and quantity of parts you need.
5. State reason for replacement.

I. MAINTENANCE CHART

You should check the items on this chart at the indicated intervals. If any of the items are loose, worn, bent or distorted, immediately have them checked and/or repaired by your authorized Sunrise supplier. Frequent maintenance and servicing will improve performance and extend wheelchair life, and help prevent injuries.

CHECK...	Daily	Weekly	Monthly	Quarterly	Annually
Charge batteries	✓				
Check tires for proper inflation level		✓			
Check batteries for proper electrolyte level (wet cell only)		✓			
Check plugs and connectors for proper connections			✓		
Check all moving parts for wear				✓	
Inspect all nuts, bolts and fasteners for looseness or wear				✓	
Inspect upholstery for wear				✓	
Remove and inspect motor brushes				✓	
Service by authorized supplier					✓

XII. WIRING DIAGRAM

WIRING DIAGRAM DETAIL (INTEGRATED CONTROL SYSTEM)

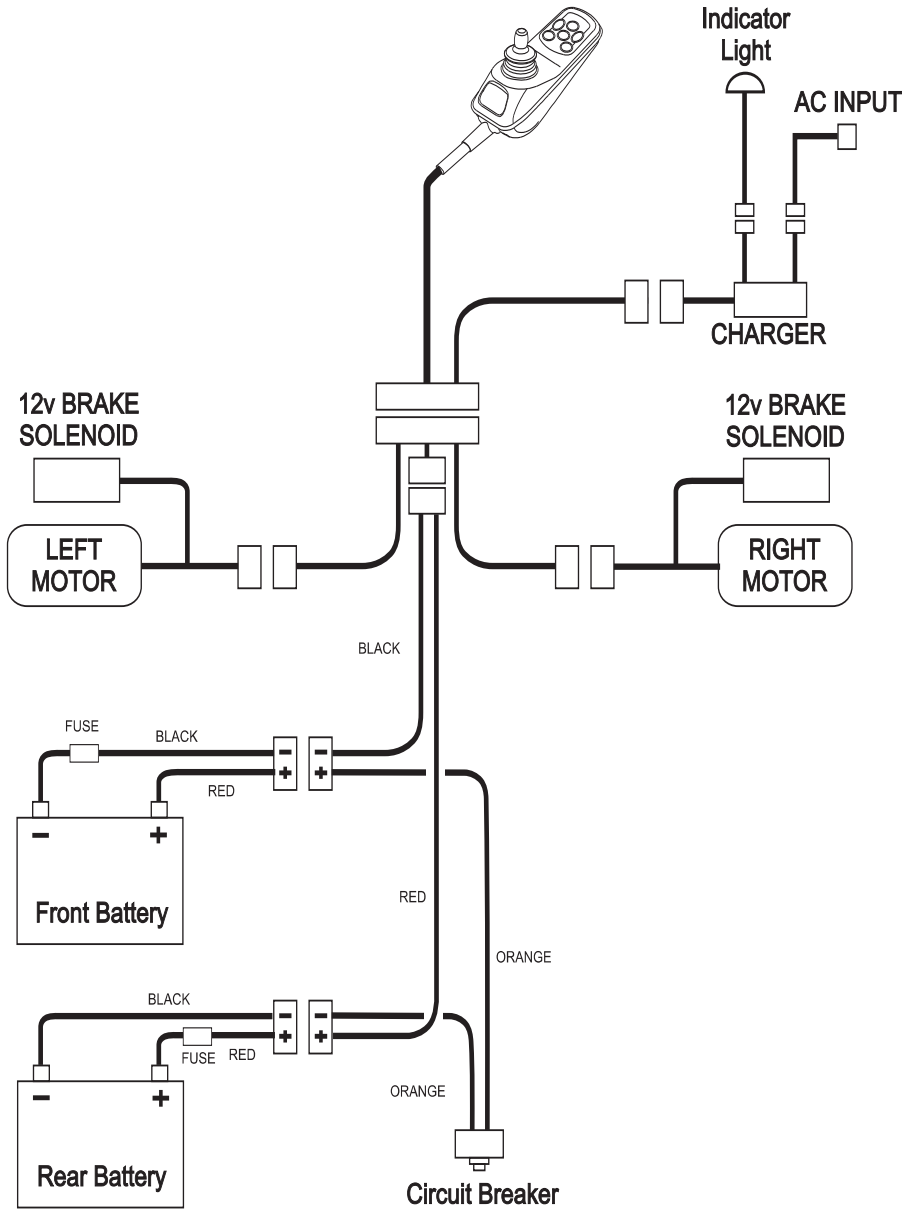

XIII. SUNRISE LIMITED WARRANTY**QUICKIE S-11****1. FOR FIVE YEARS**

We warrant the main frame of this wheelchair against defects in materials and workmanship for 5 years use of the first consumer purchaser.

2. ADDITIONAL WARRANTY

We warrant Sunrise-made components of this wheelchair against defects in materials and workmanship as follows:

- a. Main electronic controller—For two (2) years from the date of first consumer purchase.
- b. Motors, gear boxes and remote joystick—For one (1) year from the date of first consumer purchase.
- c. All other original components (such as wheels, upholstery, plastic, rubber parts and painted surfaces)—For three (3) months from the date of first consumer purchase.

3. LIMITATIONS

- a. We do not warrant damage due to:
 - Neglect, misuse, or improper installation or repair.
 - Use of parts or changes not authorized by Sunrise.
 - Exceeding the weight limit of 300 lbs.
- b. This warranty is void if the original chair serial number tag is removed or altered.
- c. This warranty applies in the USA only. Check with your supplier to find out if international warranties apply.

4. WHAT WE WILL DO

Our sole liability is to repair or replace covered parts. This is your only remedy for consequential damages.

5. WHAT YOU MUST DO

- a. Return the warranty card.
- b. Obtain from us, while this warranty is in effect, prior approval for return or repair of covered parts.
- c. Return the wheelchair or part(s), freight pre-paid, to Sunrise Mobility Products Division at: 2842 Business Park Ave., Fresno, CA 93727-1328.
- d. Pay the cost of labor to install or repair parts.

6. NOTICE TO CONSUMER

There are no other express warranties. To the extent permitted by law, any implied warranty (including a warranty of merchantability or fitness for a particular purpose) is limited to:

- a. One (1) year from the first consumer purchase, and
- b. Repair or replacement of the defective part only.

This warranty gives you certain legal rights. You may also have other rights that vary from state to state.